

DIY 工具箱

DIY Toolbox

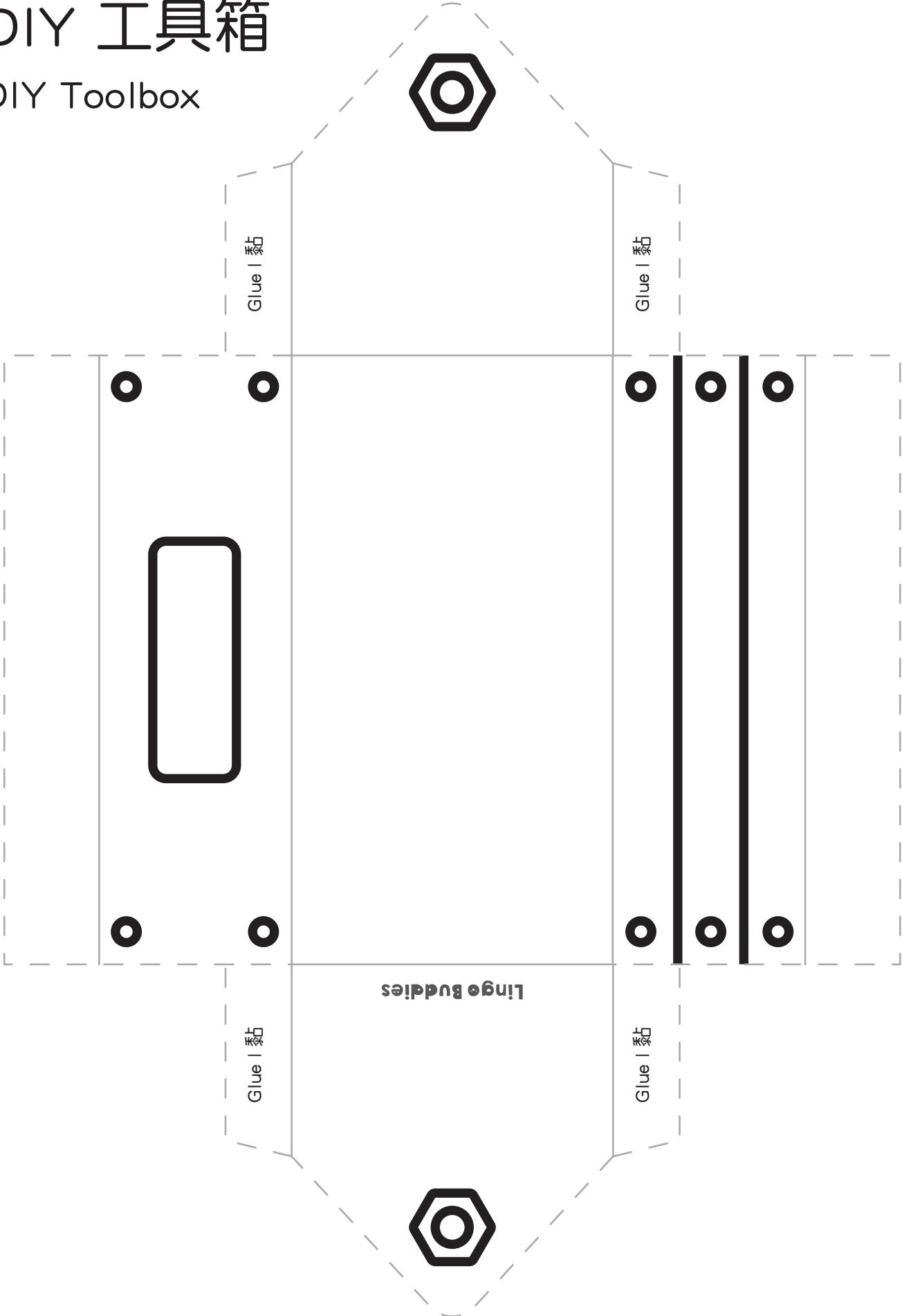

DIY 工具箱

DIY Toolbox

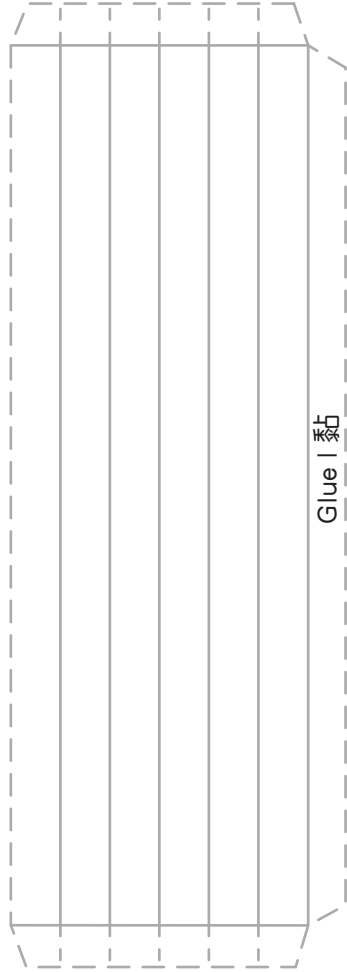

Handle

Glue | 黏



_____ 's Toolbox



Happy Father's Day



Daddy's the Best!



My Toolbox

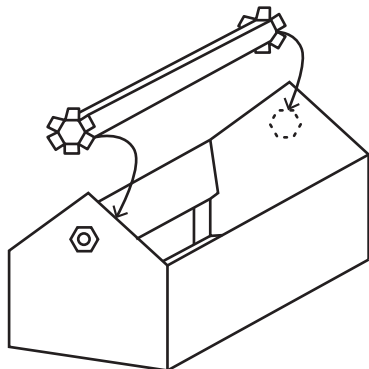

Instructions | 使用說明

1. Color in | 上色
2. Cut along dashed line | 沿虛線剪開 - - -
3. Fold along the solid line | 沿實線折疊 ———
4. Glue the indicated areas (Glue) | 黏上標示的地方 (黏)
5. Glue the ends of the paper handle to the toolbox | 將紙木棍的末端黏上工具箱

工具

Tools

上色後沿虛線剪開 | Color in then cut along dashed line

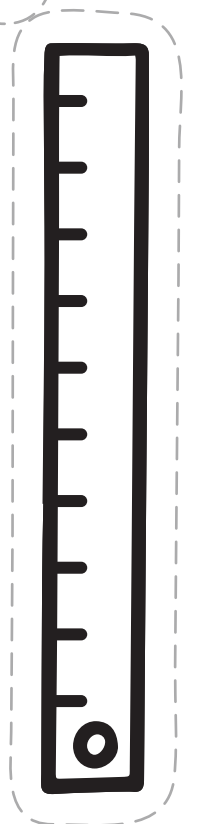
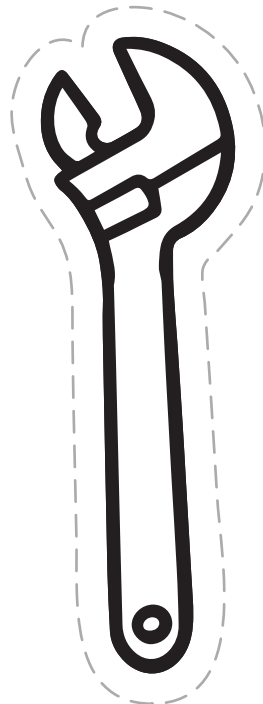
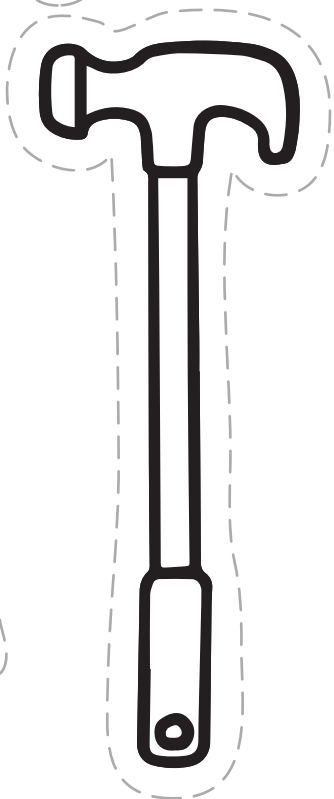
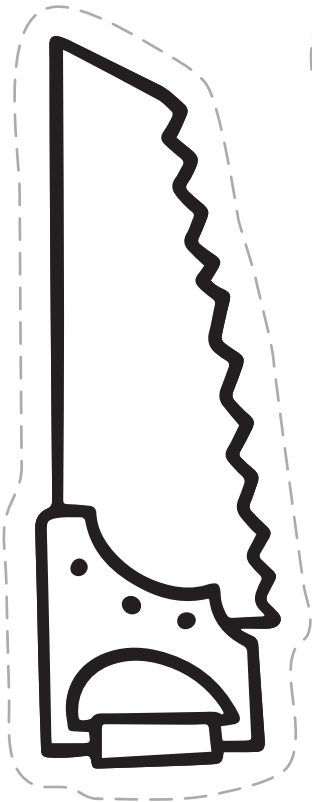
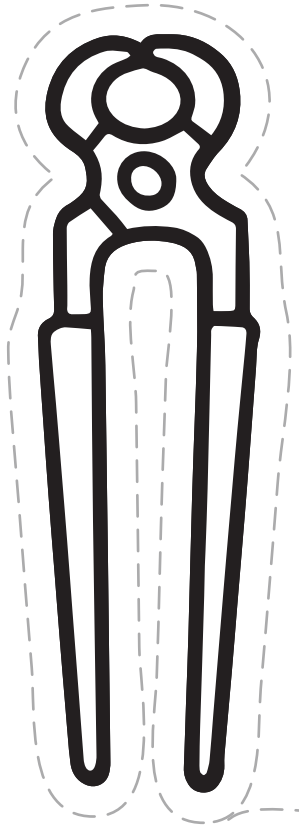
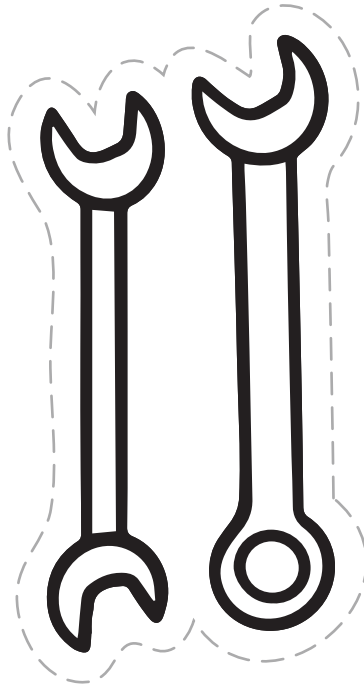

工具

Tools

上色後沿虛線剪開 | Color in then cut along dashed line

